



# PORTA DAVIT™ 1000

➤ Assembly & Operation Guide

# > Contents

|  |          |                                     |           |
|--|----------|-------------------------------------|-----------|
| <b>Correct Operation</b>               | <b>4</b> | <b>ATEX</b>                         | <b>10</b> |
| Intended Use                           |          | ATEX                                |           |
| Inspection Prior to Initial Operation  |          | Classification [Zone 2]             |           |
| Inspection Before Starting Work        |          | Classification [Zone 1]             |           |
| Maximum Capacity                       |          | Spark Formation                     |           |
| Temperature Range                      |          | Static Electricity                  |           |
| Notes for Correct Operation            |          | Inspection, Maintenance & Repair    |           |
| Disclaimer                             |          | <b>Assembly Instructions</b>        | <b>12</b> |
| Warning                                |          | <b>Dimensions</b>                   | <b>15</b> |
| Fall Protection                        |          | <b>Quality &amp; Safety</b>         | <b>16</b> |
| Additional Notes for Correct Operation |          | Regulations, Standards & Directives |           |
| Warning                                |          | Accreditations                      |           |
| IRATA                                  |          | Conformité Européenne [CE]          |           |
| <b>Inspection &amp; Maintenance</b>    | <b>7</b> | The Queen's Award for Enterprise    |           |
| Regular Inspections                    |          | Testing                             |           |
| Maintenance & Repair                   |          | Language                            |           |
| Storage & Transportation               |          | Product IPR                         |           |
| Sockets                                |          | <b>Product Labelling</b>            | <b>18</b> |
| Socket Installation                    |          | <b>Inspection Record</b>            | <b>19</b> |
| Minimum Mounting Requirements          |          |                                     |           |
| Verifying the Installation             |          |                                     |           |

# Lightweight. Portable. **Safe.**

Please read the following instructions and guidance notes carefully, before using or operating the system. They contain important information about how to handle and use the system in a safe and efficient way, avoiding danger, reducing repair costs and downtime, and increasing the reliability and lifespan of the system.

They apply for:

- Operation, including preparation, troubleshooting during operation and cleaning
- Maintenance, inspection and repair
- Transportation

It is the responsibility of the end user to adhere to the Health & Safety and accident prevention standards and legislation valid in their respective countries and any regions in which the system is being used. It is also incumbent on the user or competent person to ensure that anyone working with the equipment has the necessary medical and physical capabilities. A rescue plan also needs to be in place in the event of an emergency that could occur during the work. This document should form part of the overriding Risk Assessment and Method Statement required for each lift.

# > Correct Operation

## Intended Use

This product is intended to be used for; the lifting of goods, the lifting of personnel, rope access, or providing a safety anchor for the prevention of falls.

It is expected that all users of this product have the necessary medical and physical capabilities, are fully trained and competent in its safe assembly and use.

## Inspection Prior to Initial Operation

Each product must be inspected prior to initial operation by a competent person to ensure that the structure is safe and that it has not been damaged by incorrect assembly, transport or storage.

## Inspection Before Starting Work

Before starting work, the product assembly and all load-bearing components should be checked for visual defects as per the inspection checklist on page 7.

## Maximum Capacity

**Goods Lifting:** This product is designed to lift and lower loads up to its rated capacity. Do not exceed the capacity indicated on the product.

**Personnel Lifting:** When lifting people, the overall load limit is reduced to provide an increased safety factor. The maximum capacity permitted by the personnel winch/accessory used in conjunction with the product also needs to be taken into account.

Only chain hoists with a capacity of up to 1000kg are suitable for this Davit. The structure has been designed to take into account the weight of a standard chain block but, if a device with a significant additional weight is being used, then this needs to be included within the overall capacity. Care should also be taken when using any lifting device other than a manual chain hoist in case the dynamic effects of this reduce the overall capacity of the davit. REID Lifting's representatives can provide additional advice on this if required.

The table below gives the maximum WLL and radius for each of the standard models.

|                  | Max. Goods WLL | Max. Personnel WLL | Max. Radius |
|------------------|----------------|--------------------|-------------|
| PORTA DAVIT 1000 | 1000kg         | 300kg              | 1200mm      |

Please be aware that the maximum radius is achieved when the Davit is being used at approximately 75% of its maximum capacity.

## Temperature Range

This product can be operated in ambient dry temperatures between  $-20^{\circ}\text{C}$  and  $+55^{\circ}\text{C}$  ( $-4^{\circ}\text{F}$  and  $131^{\circ}\text{F}$ ). Consult your supplier in case of extreme working conditions.

## Notes for Correct Operation

- › We recommend the use of load-sensing or overload protection devices on all lifts
- › The risk assessment and method statement must consider any factors that might apply additional loading to the system during lifting operations
- › Suitable, appropriately rated winches and connection plates must be used for all applications
- › Take care when transporting and storing the system to avoid damage
- › Assemble only as instructed (ensure all bolts are present and fitted correctly as per instructions)
- › We recommend that appropriate PPE are worn when using the equipment
- › Do not assemble the Davit in any non-approved sockets
- › Make sure that the kingpin shaft is correctly seated in the socket before use
- › Do not use this product if it does not rotate freely in the bearing or if the bottom flange is fouled in any way that prevents that free rotation

- › Attach the hoist to the dedicated lifting point only, making sure it is attached in a way that does not expose the user to danger by the hoist, chain or load
- › Always ensure that the product is set up in its mounting socket in a safe location where there is no risk of falling into the hazard or lift area
- › Only attach the load to the lifting points on the head or winch line
- › Do not allow the load to swing
- › To avoid side pull, lowering and lifting should only be carried out when the load chain forms a straight and vertical line between the load and lifting attachment point.
- › Contact your supplier before using the davit in (special atmospheres) extreme conditions

## Disclaimer

- › REID lifting sockets & extensions have been designed, developed and tested for safe use with REID equipment and form a key part of the integrity of the total system
- › All sockets have a maximum moment based on the maximum reach setting of the Davit, and the socket installation and verification tests performed

- › If non-standard, third-party sockets are used, REID Lifting's Declaration of Conformity & Incorporation and warranty for the products is no longer valid and the system becomes the responsibility of the client.

## Warning

- › The equipment should not be used outside of its limitations, or for any purpose other than that for which it is intended
- › Do not lift or transport loads while personnel are in the danger zone
- › Do not allow personnel to pass under a suspended load
- › Never leave a suspended load unattended
- › Be aware of any adverse weather conditions such as strong or gusty winds which could impose additional horizontal loads and affect the stability of the structure. Stop using if weather is impacting on lifting.
- › Don't allow the load to hit the system

# ➤ Correct Operation

## Fall Protection

When being used as part of a fall protection system the user must use a body harness and retractable device or shock absorber to EN355 that limits the maximum allowed force (M.A.F.) to 6kN. Winches used with the system should comply to EN1496:2017 or equivalent.

In the event of simultaneous goods and personnel combined lifting or when being used as a fall arrest system in sub-zero and wet conditions contact the supplier as capacities may be reduced.

While this product will have the capabilities stated on the system, it is only one part of a fall arrest system which is only as strong as the lowest rated component. Each lift must be properly planned, and all weights clearly known along with the WLL and constraints of all fall arrest system devices.

The capabilities stated in the table below apply to standard range systems only. If unsure about your system consult serial labels, information filled in on page 19 or consult your supplier.

|                  | Max No. Persons for Fall Arrest |
|------------------|---------------------------------|
| PORTA DAVIT 1000 | 2                               |

## Additional Notes for Correct Operation

- Ensure suitable and appropriately rated winches and connection plates are used for all applications
- Never walk away from the structure whilst connected to the equipment (either by winch or fall arrest block)
- When using the davit as a fall arrest anchor, ensure there is adequate fall clearance when working at height
- Always consider the potential effects of sharp edges, chemical reagents, electrical conductivity, cutting, abrasion, climatic exposure on the fall protection lifelines, and the effect of offset forces as a result of pendulum falls
- When being used for fall protection, the user must remain within the footprint of this product
- Where regulations require, each installation must be approved by a qualified person

## Warning

- When using the Davit in conjunction with any other manufacturer's fall protection products, it is essential to read the instructions for those products to check their suitability and restrictions for use
- REID Lifting does not recommend that the davit is used for personnel and goods lifting at the same time
- It is essential for safety that the product is withdrawn from use immediately and not be used again until confirmed in writing by a competent person should,
  1. Any doubt arises about its condition for safe use or;
  2. It has been used to arrest a fall

## IRATA

This product is suitable for rope access and has been tested to 15kN. Static load as per test requirements of IRATA international code of practice (ICOP).

Standard socket extensions are suitable for rope access when used with a maximum radius of 1200mm.

The following information is based on REID Lifting's recommendations and does not remove the responsibility of the user to comply with the relevant regulations and standards that are valid in the respective countries and regions where the system is being used.

Before use, the product should be inspected for visual defects using the checklist below:

- Ensure that the kingpin, column, jib and backstay are free from dents and indentations and are not showing any signs of distortion.
- Ensure that there is no damage to the shackles.
- Ensure that no bolts are loose.
- Ensure radius adjustment plate and pin are free from damage
- Check any attachments for signs of damage.

Test the free rotation of the kingpin and ensure that it is fully engaged in the socket. The lower bearing at the bottom of the column needs to be flush with the top of the socket.

## Regular Inspections

To ensure that the product's remains in safe working order it must be inspected regularly by a competent person. We recommend inspections every 6 months for personnel lifting and every 12 months for goods only, unless adverse working conditions or profile of use dictate shorter periods. The components of the system frame need to be checked for damage, wear, corrosion or other irregularities. It may be necessary to disassemble the system frame in order to do this. Particular attention should be paid to checking the profiles for denting, making sure there is no wear or elongation on the bolt holes and ensuring that the jib section retracts smoothly.

Any necessary repairs should only be carried out by an approved specialist workshop using original spare parts. It is recommended that once inspected or repaired, the device is marked with the date of the next inspection.

Inspections are instigated by the user. If detailed information is required on inspection and test criteria, please refer to your supplier's technical department. The equipment Inspection Record is on page 19.

If using the system in explosive atmospheres, see additional section titled ATEX.

# › Inspection & Maintenance

## Maintenance & Repair

In order to ensure correct operation, the conditions for inspection and maintenance must be complied with. If any defects are found, stop using the product immediately.

No alterations or additions to the equipment should be made without the written consent of the manufacturer. Any repair must be carried out in accordance with the manufacturer's procedures.

It is recommended to maintain the equipment in a clean and dry manner. Cleaning is suggested using a sponge or cloth with warm, soapy water, rinsing and allowing to dry.

Most of the structure is constructed from aluminium with steel fasteners; non-metallic parts are constructed from acetal co-polymers, polyethylene and polyester.

## Storage & Transportation

When transporting the components, take note of all the manual handling considerations.

Do not throw the product down or stack any items on top of it.

Always place carefully and securely on the ground to avoid damaging the equipment.

## Sockets

REID's Davits need to be anchored to a suitable structural surface/foundation capable of withstanding the applicable loading.

We strongly recommend that a structural engineer validates this prior to installation of the product.

This product can be supplied with one of the sockets specified below (only sockets supplied by REID Lifting are approved to be used with this product):

- › The Top Mount socket is for use on flat horizontal surfaces. It can be installed onto concrete using resin bonded anchors or into steel work using bolts
- › The Side Mount socket can be installed using resin bonded anchors or mechanical anchors
- › The Bridge Mount socket is for mounting into steel work and walkways
- › The Cast & Resin Bonded sockets can be cast into new concrete or resin bonded into existing concrete

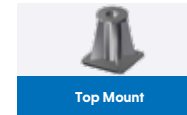

Top Mount



Side Mount



Bridge Mount



Cast & Resin Bonded



## Socket Installation

Socket installation should only be carried out by a qualified person, with the ability to specify the anchors, resin, and fasteners necessary to ensure an installation that is safe for use. If in any doubt about the calculation of loads, contact your REID Lifting representative.

Depending upon the socket type, there are a number of different installation options. If bolts are being used for this, then these should be minimum grade 8.8 BZP or if stainless, grade A4 or equivalent.

When installing the socket, it is important to ensure that the top face is as level as possible, with misalignment no more than 3 degrees from the horizontal.

Note: Site specific information regarding the installation of REID Davit sockets CANNOT be detailed within this operating manual as each site/structure is different. A qualified engineer MUST design and approve each installation based on the minimum mounting requirements, site information and experience.

## Minimum Mounting Requirements

The supporting structure and installed base must be capable of withstanding the following:

- › For personnel, 12kN at the device's maximum radius in all worst-case loading directions.
- › For rope access, 15kN at the device's maximum radius in all worst-case loading directions.
- › 150% of the goods capacity at the device's maximum radius in all anticipated worst-case loading directions

For more detailed requirements please contact REID Lifting.

## Verifying the Installation

We recommend that the socket installation is tested before initial use, particularly when using resin bonded anchors. When verifying the installation, testing should be to no more than 125% of the goods capacity at its maximum radius or 6kN at its maximum radius for personnel. All tests should be carried out in all anticipated worst-case loading directions, sustained for a duration of 3 minutes.

If the socket installation can't be tested, each anchor should be isolated and tested individually applying the applicable tension and shear loading. Please contact REID for more details

Following initial socket installation verification tests, we recommend periodic visual examination rather than overload tests for the socket or davit. If, as a result of the visual examination, a load test is judged to be required, then we recommend 100% load test and certainly no more than 125%.

## ATEX

This product has been designed for use in explosive atmospheres in line with the following requirements and information. Any use which differs or exceeds this is considered incorrect and REID Lifting Ltd will not accept any responsibility or liability for damages resulting from false application. The risk is solely with the user. If the product has been customized in any way, then it may not comply with standards and no longer be suitable for use in explosive atmospheres. If this is the case, then the product will not have any of the markings below. If in doubt, please contact your REID representative.

## Classification [Zone 2]

As standard, the product meets the requirements of Category 3 equipment for use in Zone 2 explosive atmospheres, providing a normal level of protection where mixtures of air and gases, vapours or mists or by air and dusts mixtures are unlikely to occur or, if they do occur, are likely to do so only infrequently and for a short period only.

The product will have the following identification on the serial label:

### As Standard for Zone 2 Environments:

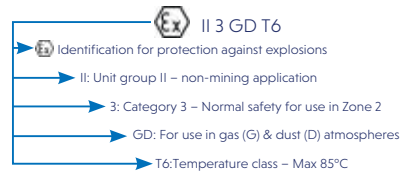

## Classification [Zone 1]

Available as an upgrade, the product can be supplied to meet the requirements of Category 2 equipment for use in Zone 1 explosive atmospheres, providing a high level of protection where mixtures of air and gases, vapours, mists or by air and dusts mixtures are likely to occur.

The product will have the following identification on the serial label:

### As an Upgrade for use in Zone 1 Environments:

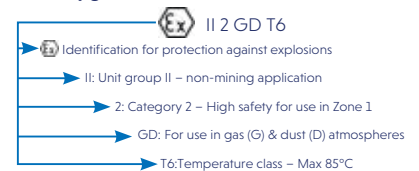

## Spark Formation

There is an increased danger of ignition when certain material pairings clash, namely non-corrosion-resistant steel or cast iron against aluminium, magnesium or pertinent alloys. This applies especially in the case of rust or surface rust. When assembling the product and inserting fastening components, these must therefore be clear of rust and debris of any kind. As stated previously, care must be taken to ensure the product is handled in a suitable manner, never thrown down and always placed carefully onto the ground.

REID recommends the use of corrosion resistant tools when assembling this product to prevent the possibility of any sparks.

## Static Electricity

For Zone 1 and 2 applications, there is a potential risk of static electricity build-up leading to an incentive spark. Although the risk of such ignition is unlikely, the system must be earthed during assembly and use. The sockets should be in direct contact with the ground and there should be no membrane separating the socket from the ground. If the route to earth for the structure cannot be guaranteed, then an earthing cable should be used. For Zone 2, additional earthing cables are required to the shackles and/or load to avoid isolation of components.

## Inspection, Maintenance & Repair

Special attention should be given to dust deposits on the structure, especially in areas where the profiles come into contact, and should be wiped clean and care taken not to apply materials that could create electrostatic charging.

Additionally, the kingpin should be checked to ensure it rotates freely and the lower bearing must be ensured to be fixed to the structure with no possibility of a build-up of debris between the contact surfaces.

The structure is predominantly constructed from aluminum which will not rust. However, there are steel components used throughout. These are the fasteners, shackles and sockets. Where there is sign of any rust deposits on the aluminium structure, it should be wiped clean as above and, where there is sign of rust on a steel component, that component should be removed from use and the structure not used until a replacement is fitted.

If using the product in explosive atmospheres, in addition to the Regular Inspection and Maintenance information above, these additional instructions should be followed:

Inspections must be instigated by the user prior to each use if used in a potentially explosive atmosphere.

Inspections and maintenance must be carried out at a safe distance away from an explosive atmosphere.

# ► Assembly Instructions

The PORTA DAVIT 1000 and its constituent components are described in the image below.

The use of a socket extension is optional and the socket type may vary between a Top Mount, Side Mount, Bridge Mount, Cast In or Resin Bonded, depending on application.

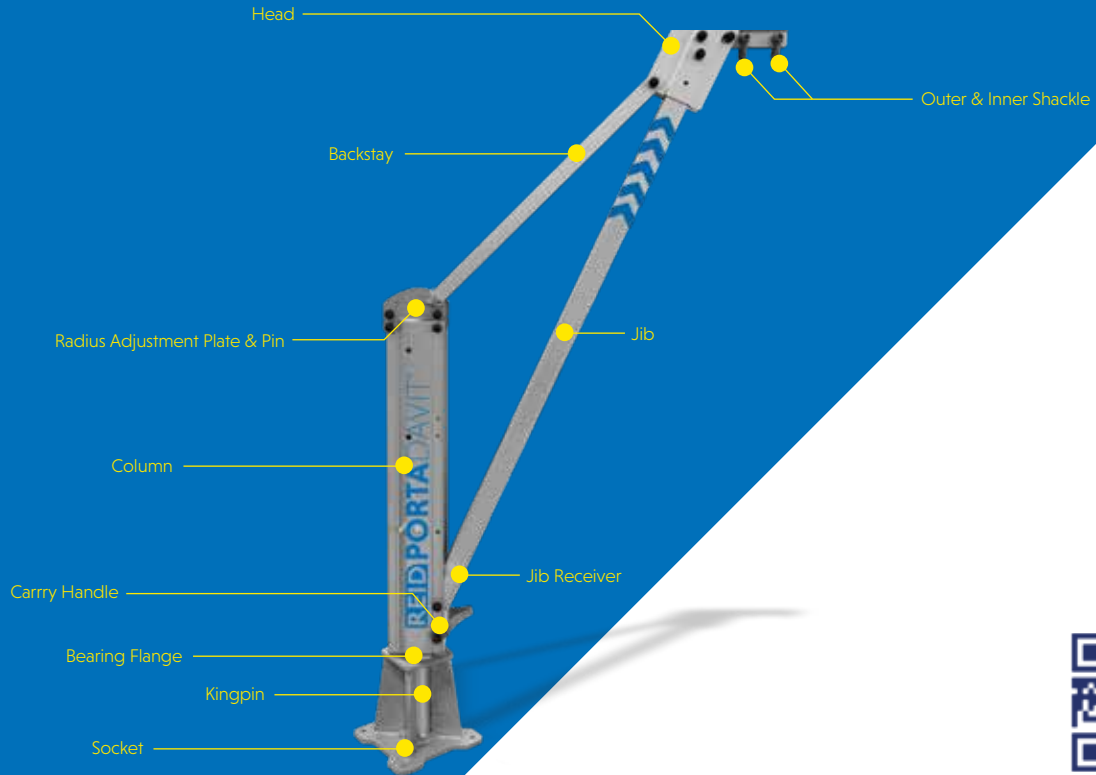

Appropriate PPE should be worn: ► Gloves ► Protective Footwear ► Hard Hat



## Assembling the PORTA DAVIT 1000

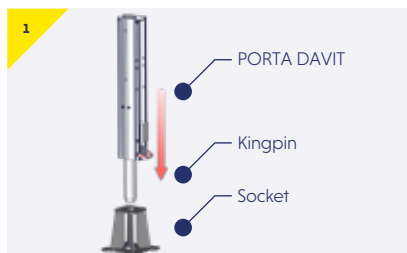

- > Insert the PORTA DAVIT into the socket as shown
- > Ensure the kingpin is fully inserted and the bearing flange is in full contact with the socket flange



- > Rotate the jib receiver outwards so it able to accept the jib



- > Insert the upper the head into the jib
- > Attach a chain block to the shackles



- > Insert the jib into the jib receiver

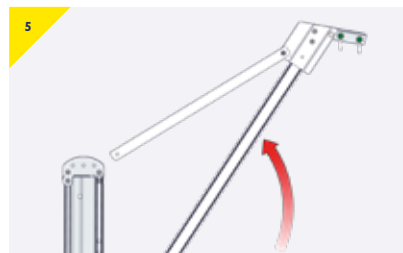

- > Rotate the backstay and attach to the radius adjustment plate

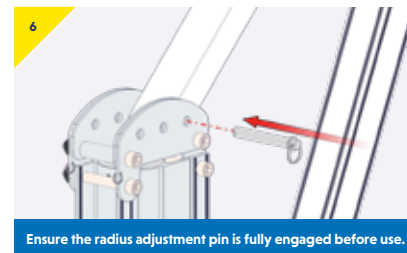

Ensure the radius adjustment pin is fully engaged before use.

- > Insert the pin into the required operating radius to secure in place

# > Assembly Instructions

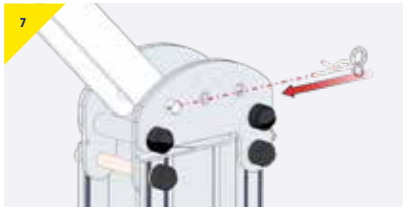

For disassembly, reverse steps 1-7.

- > Insert the retaining clip to secure the pin in place

## Adjusting the Radius

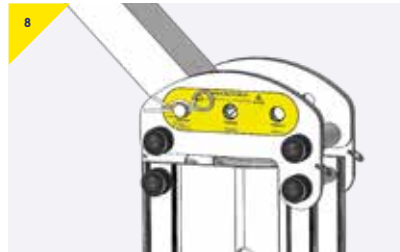

- > The operator can choose the most suitable radius for use, by inserting the pin in the adjustment plate

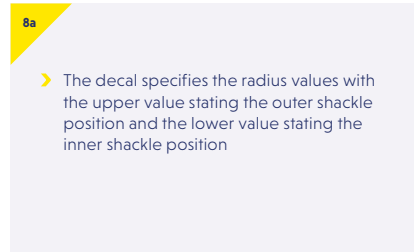

- > The decal specifies the radius values with the upper value stating the outer shackle position and the lower value stating the inner shackle position

## Davit Rotation Bar

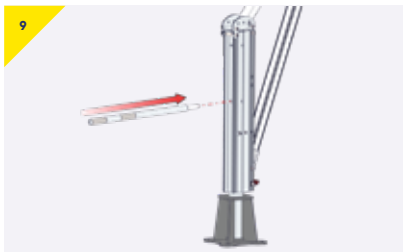

- > Attach the rotation bar into one of the three mounting positions to aid Davit rotation



- > The rotation bar can be set at 90°, 180° or 270°

# > Dimensions

- A** Overall height from top of socket
- B** Height to shackles
- C** Radius to outer shackle
- D** Radius to inner shackle

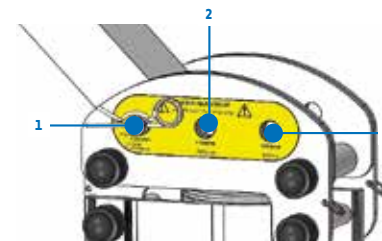
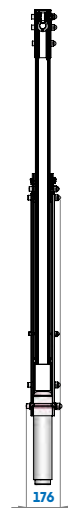
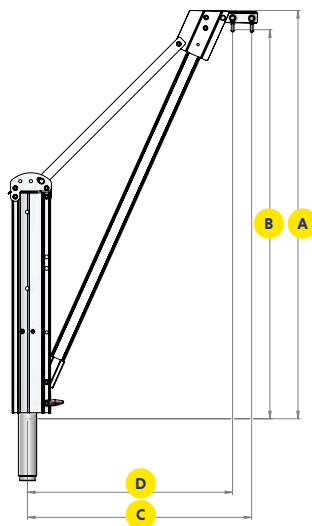

| WLL    | Radius Adjustment | Dimensions [mm] |      |      |      |
|--------|-------------------|-----------------|------|------|------|
|        |                   | A               | B    | C*   | D*   |
| 1000kg | 1                 | 2100            | 2000 | 1200 | 1100 |
|        | 2                 | 2150            | 2050 | 1100 | 1000 |
|        | 3                 | 2200            | 2100 | 1000 | 900  |

\*Radii achieved at ≈ 75% WLL

# › Quality & Safety

## Regulations, Standards & Directives

This product complies with the following:

- › ATEX Directive - 2014/34/EU
- › Machinery Directive 2006/42/EC
- › PPE Regulation (EU) 2016/425
- › The Provision and Use of Work Equipment Regulations 1998 (S.I. 1998 No. 2306)
- › The Lifting Operations and Lifting Equipment Regulations 1998 (S.I. 1998 No. 2307)
- › In conformity with EN795:2012 and AS/NZS 5532:2013

It is essential to adhere to the safety regulations of the respective country for using manual lifting equipment.

## Accreditations

Quality and Safety are at the heart of the REID Lifting ethos and we are committed to maintaining the very highest standards. With this in mind, we have undertaken external accreditations to ensure we stay focused on what is important to our clients and users, and ahead of market trends and developments.

REID Lifting is continuously audited by Lloyds Register Quality Assurance (LRQA) for approval of its Integrated Management System combining quality systems management, environmental issues and the health and safety practices within the company.

- › ISO 9001:2015 - Quality management system which assesses an organization's ability to consistently provide products that meet customer and applicable regulatory requirements and aims to enhance customer satisfaction.
- › ISO 14001:2015 - Specifies the requirements for implementing environmental management systems throughout all areas of the organization.
- › ISO 45001 – Health & Safety Management System

- › LEEA Membership - REID Lifting is a full member of the Lifting Equipment Engineers Association (LEEAA membership 000897). REID Lifting conforms to the main aims of the association which is to achieve the highest standards of quality and integrity in the operations of members. Entry qualifications are demanding and strictly enforced through technical audits based on the Technical Requirements for Members.
- › IRATA - REID Lifting is an associate member of the Industrial Rope Access Trade Association (IRATA International membership number 148). REID Lifting works in accordance with the IRATA Code of Practice and, in doing so, contributes to promote the development of safe systems.



## Conformité Européenne [CE]

REID Lifting's products have been designed, tested and approved (as appropriate) by the Conformité Européenne. This certifies that REID Lifting's products meet the demands of the European Directives and Regulations regarding Health and Safety requirements. The EC type-examination for this device has been carried out by SGS United Kingdom Ltd, 202b, Worle Parkway, Weston-super-Mare, BS22 6WA, United Kingdom (CE body no.0120) in accordance with Module B of the PPE Regulation. The EC quality assurance system for this device has been carried out by SGS Fimko Oy, Takomotie 8, FI-00380 Helsinki, Finland. (CE body no. 0598) in accordance with Module D PPE Regulation (EU) 2016/425.

## The Queen's Award for Enterprise

REID Lifting has been awarded this prestigious award on four occasions for design, development and sale of lightweight, portable and safe lifting solutions.

- Innovation category 2006 and 2013
- International Trade 2013 and 2018

## Testing

Testing and technical file review are integral parts of our design and manufacturing process. External verification of products is undertaken where appropriate, using government approved Notified Bodies.

All products have been thoroughly type tested. Each product is supplied with a certificate of conformance and individual record of thorough examination or test.

## Language

It is essential for the safety of the user that if this product is re-sold outside of the original country of destination, the reseller shall provide instructions for use, maintenance, inspection and repair in the language of the country where it will be used.

## Product IPR

Intellectual property rights apply to all REID Lifting Ltd products. There are patents in place, or pending, for:

**PORTAGANTRY™** | **PORTAGANTRY<sup>RAPIDE</sup>™** |  
**PORTADAVIT<sup>QUANTUM</sup>™** | **TDAVIT™**

All product names are trademarks of REID Lifting Ltd:

**PORTAGANTRY™** | **PORTAGANTRY<sup>RAPIDE</sup>™** |  
**PORTADAVIT™** | **PORTABASE™** | **TDAVIT™** |  
**PORTAQUAD™**

# ➤ Product Labelling

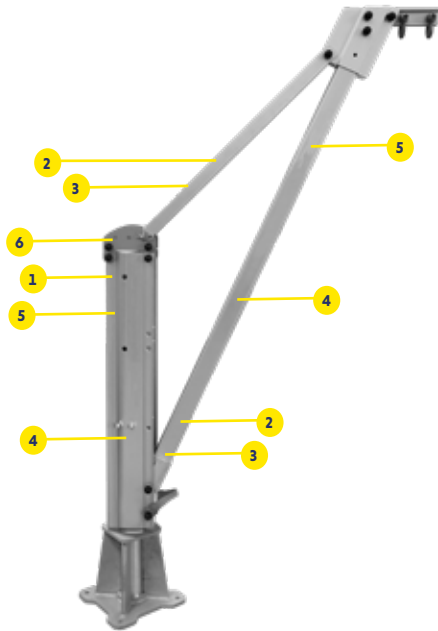

## Product labelling

The following labels must be present on the product and must be legible.

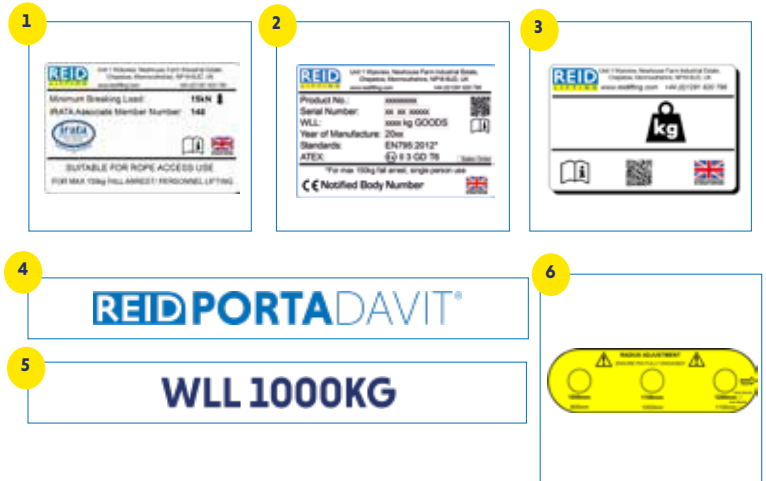



Insert data from serial numbers found on product into table here:

## Marking

The serial labels indicate:

- The product identification number
- The product's unique serial number
- The goods' capacity (WLL) of the device
- The year of manufacture
- The standards to which the device is approved
- The ATEX rating of the product (if applicable)
- CE Marking
- Minimum braking load (MBL)

---



---



---



---



---



---



---



---

## Periodic Examination & Repair History

| Date | Inspected by | Pass/Fail | Comments |
|------|--------------|-----------|----------|
|      |              |           |          |
|      |              |           |          |
|      |              |           |          |
|      |              |           |          |
|      |              |           |          |
|      |              |           |          |
|      |              |           |          |

# Contact Us

## Head Office, UK

Unit 1 Wyeview  
Newhouse Farm Industrial Estate  
Chepstow  
Monmouthshire  
NP16 6UD  
United Kingdom

- > +44 (0)1291 620 796
- > [enquiries@reidlifting.com](mailto:enquiries@reidlifting.com)
- > [www.reidlifting.com](http://www.reidlifting.com)

All information herein is copyright protected by REID Lifting Ltd. All company and product names are Trade Mark and Trade Name protected and all REID Lifting Ltd. Product IPR is protected under Patents, Patents Pending and/or Design Rights.

 Printed using environment friendly processes and materials.